

ShoreStation[®]

At the forefront of shorefront since 1959

BOAT LIFTS



Simple and swift from launch to lift.

the ease of speed

Sure, a ShoreStation lift is one of the fastest on the market, but it's more than that. The unmatched speed, versatility and dependability translates to more time on the water. From the effortless centering of the load guides, to the reliable confidence of the boat stops, to the unmatched ease of the ShoreScreen, ShoreStation allows you to focus on the reason you came to the lake in the first place ...to relax and enjoy.

**SEE THE LIFT
IN ACTION**



Worry Free Landing

Bring your boat to a perfect position every time with ShoreStation's system of quality products. Our bow and motor stops help prevent you from overrunning the lift, while our boat guides allow for an easy entrance even in wind and waves.



Convenient Wireless Operation

ShoreStation has everything you need to create the custom waterfront of your dreams. Raise and lower your ShoreStation® Hydraulic Lift or ShoreScreen with this handy remote transmitter. Two come standard with all powered lifts.



Solar Battery Charging System

Never miss another moment on the water. Power your lift with clean, free solar power. Our speedy 20 watt charger features solar regulator drainage protection, saving your battery from permanent damage caused by overcharging.

Maximum Protection for Your Boat and Lift

Our patented hydraulic boat lift design not only gives you the confidence to load or lower your boat in rough water, but the 'high and dry' design keeps key components above the water. This translates to significantly less downtime, less maintenance and more summer fun time.

Quickly Secures Boat

Made from the highest quality materials, our innovative hydraulic boat lift is one of the fastest and safest lifts on the market today. When you have a hydraulic lift, there's no need to worry about wind and waves getting in your way. This lift will give you confidence to safely land and secure your boat in less than ideal conditions.



From Covered to Uncovered in Seconds

We know how much your watercraft means to you and how you want to keep it in showroom condition. With our ShoreScreen Power Curtain there's no more hassling with traditional heavy boat covers and snaps. Protect your boat from damaging UV rays, and create a barrier against wind-blown debris, insects and birds to ensure your boat stays looking great, year after year.



Safe. Simple. Solar.

ShoreStation's solar-powered systems harness the sun's energy to power your boat lift, making your lift more cost-effective, efficient and maintenance-free.

CONVENIENCE & SAFETY - Skip the electricity - it's simple with solar. With ShoreStation's solar-powered system, you avoid the need for AC power on your dock, allowing you to focus on what's important - enjoying life's special moments.

PEACE OF MIND - Even during a power outage, our solar-powered DC system lifts remain fully functional ensuring there is always power to your lift. What's even better? Solar Powered DC systems last longer and perform better in marine environments.

EASE OF MAINTENANCE - With solar-powered lifts, gone are the days of hassling with battery maintenance. Simply plug it in, connect to battery, and you're ready! Solar power quickly charges the lift battery and then switches to maintenance mode to protect the battery from overcharging - effectively preventing battery drain and maintaining peak power.

The panel can be left on the battery year round eliminating the need to remove it for winter storage.

SOLAR BATTERY CHARGING SYSTEM

Power the lift with clean, free solar power. The speedy 20 watt charger features a solar regulator to prevent battery drain and protect your battery from permanent damage caused by overcharging.



Defy convention, and push technology to the limits...

Boats are Changing, Lifts are Changing with them.

Our unique hydraulic lift design allows you the freedom to choose how you experience owning a lift. The benefits of ShoreStation's Permanent Lifts are endless. With features that allow for greater flexibility in dock design and lift placement, your ShoreStation is key to complementing your waterfront view.

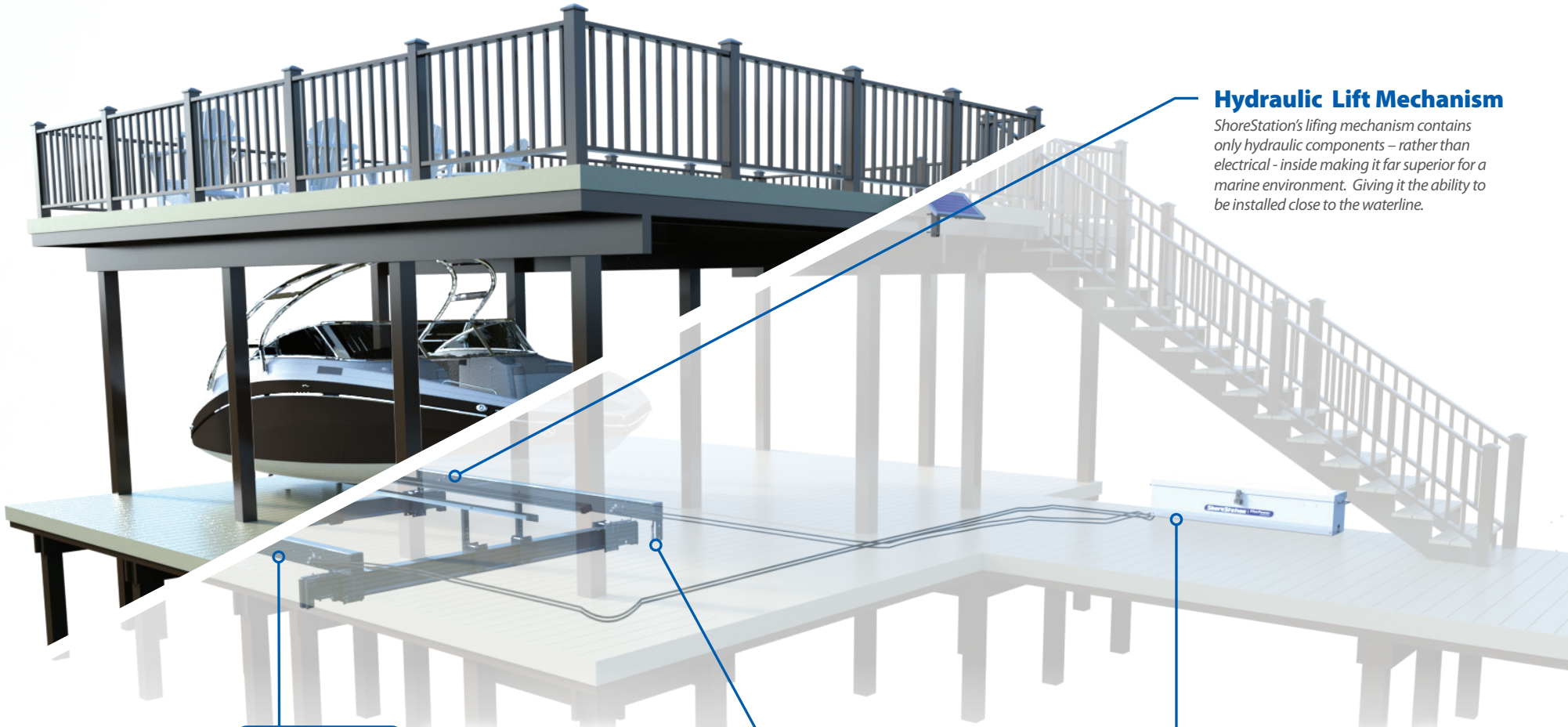

Hydraulic Lift Mechanism

ShoreStation's lifting mechanism contains only hydraulic components – rather than electrical - inside making it far superior for a marine environment. Giving it the ability to be installed close to the waterline.

No Winding Cables

Pulling cables with hydraulic cylinders – rather than winding - eliminates bird nesting issues with slack conditions. With the cable position remaining fixed while lifting, the platform can be installed close to the deck.

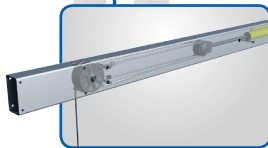

Built-in Safeguards

Designed to stall before lifting damaging loads. Avoiding issues with overloading or platform lift drag.

Remote Hydraulic Power

Powered remotely via hydraulic hoses. Allowing the DC power unit to be mounted far from the lift. Gone are the days of electrical components near the water.

From simple to sophisticated.
Overhead to under-deck.

The options are endless!

This isn't your typical boat lift! Our unique above-the-water hydraulic design allows you to get creative so your shorestyle complements your lifestyle.

Install high for tidal fluctuation, deck level for a low profile look, or deck over the platform.

Hang it from the ceiling, hide it in the roof or mount it under the deck.

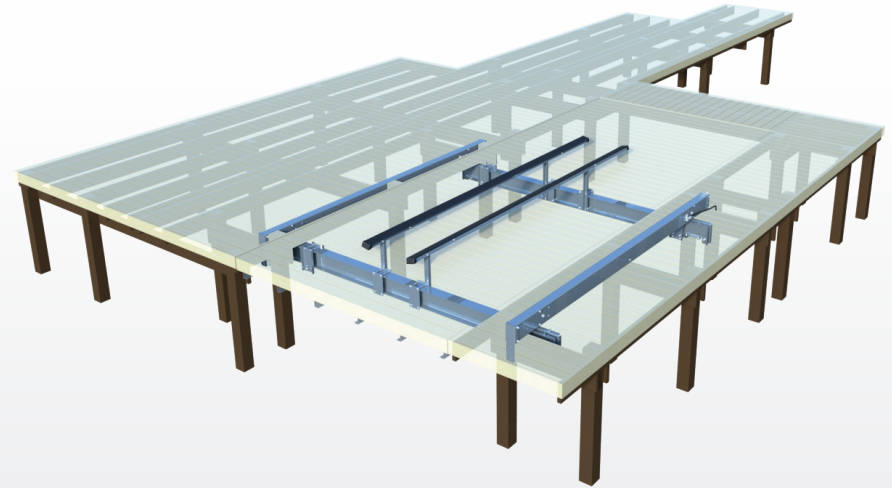
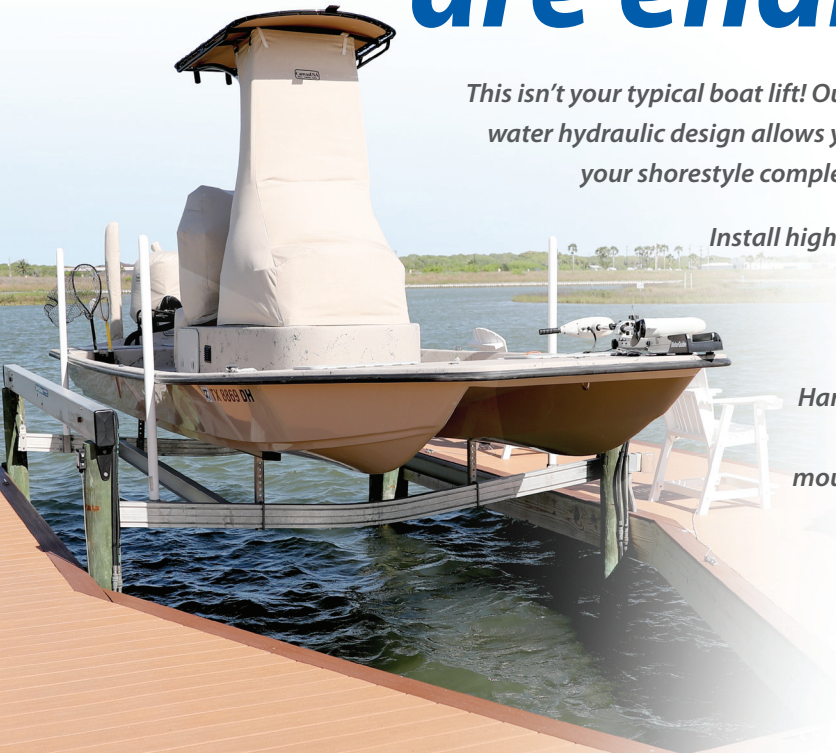

Platform

Don't spoil your view with an unsightly lift. ShoreStation's platform lift not only looks great, but it provides easy access to your boat for entrance, cleaning and servicing.

4,000 lb to 20,000 lb capacities. Up to 16' lift travel.

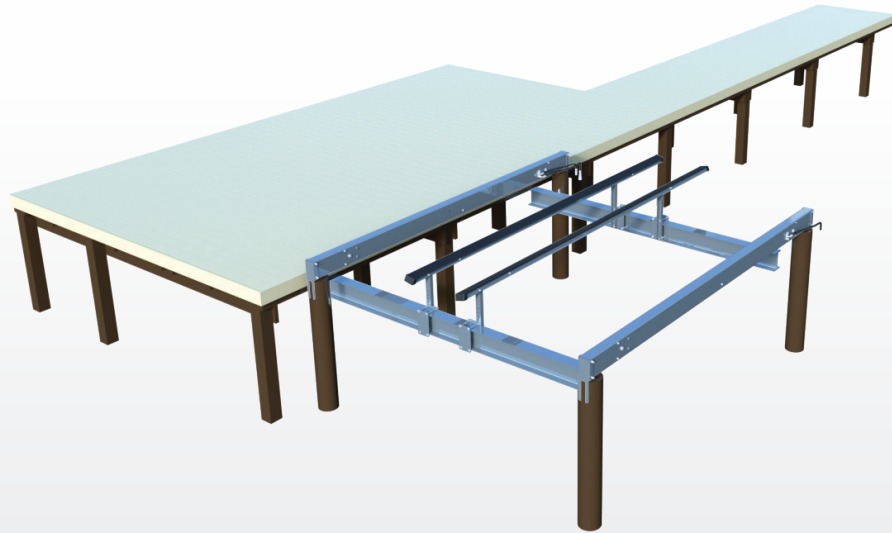

Piling

This lift design is a traditional approach. Install the lift tubes high for tidal fluctuation or deck-level for a low profile look that doesn't interfere with accessing your boat.

4,000 lb to 20,000 lb capacities. Up to 16' lift travel.

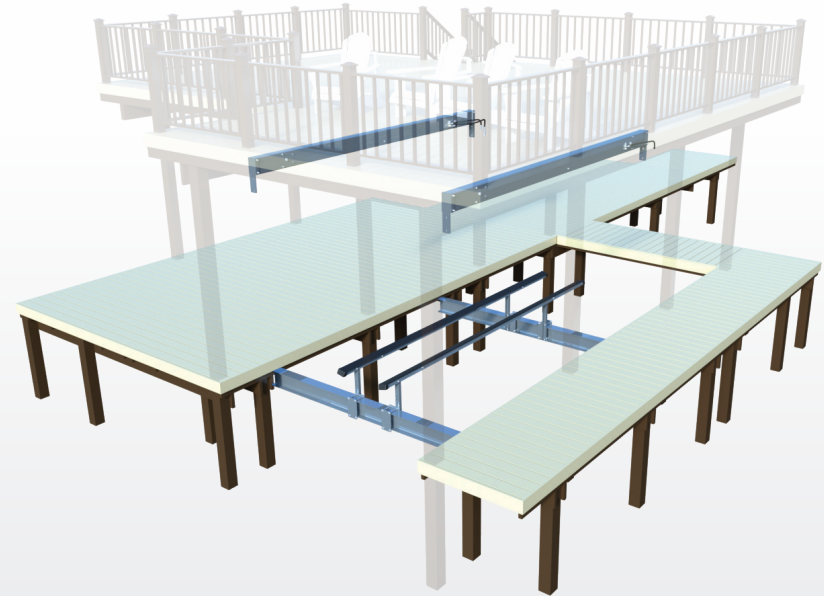

Boathouse

Install in new or existing boathouses. Hang it from the ceiling, hide it in the roof or mount it on pilings under the deck.

4,000 lb to 20,000 lb capacities. Up to 16' lift travel.



ShoreScreen

*From covered to uncovered in seconds.
Protect your boat with this high-tech screen.*

THE ULTIMATE IN BOAT PROTECTION -

Protect your boat from damaging UV rays, and create a barrier against wind-blown debris, insects and birds to ensure your boat stays in showroom condition. No more hassling with traditional heavy boat covers and snaps.

FAST, TROUBLE-FREE OPERATION - Two drive motors positioned on opposite corners roll all four screens simultaneously without complicated cables or pulleys. The adjustable limit stop allows the user to preset desired heights.

SUN-CONTROL SCREENING WITH

MICROBAN - The black SunTex 80 woven mesh gives the ShoreScreen a subdued shadowy effect. It absorbs and dissipates up to 80% of the sun's heat while allowing air flow. The microban technology prevents mildew build-up when rolled up.

CONVENIENT WIRELESS OPERATION -

Simply push a button on the remote and the cover quickly raises and lowers over your boat. You can even use the same remote for both your lift and ShoreScreen.



**SEE THE
SHORESCREEN
IN ACTION**

Boat Guides and Bow Stop

Guide your boat properly into position with boat load guides. Our fully adjustable, low maintenance, poly covered guides provide maximum protection for your boat and lift.

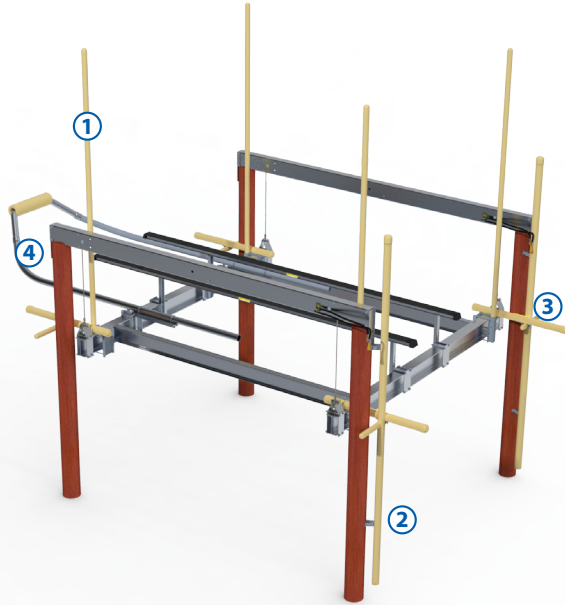

- ① 10' POST**
Keeps the boat bow centered when landing in high wind or waves. Mounts on the lifts platform to provide full adjustability.
- ② GLIDEPOLE 148"**
Mounts on the corner piling to provide a visual aid and guidance when centering and landing your boat on the lift. The durable aluminum core with non-marring UV stable poly sheath are sure to protect your boat while adsorbing repeated shocks.
- ③ PILING GUIDES**
Mounts to the lift platform to retain the lifts position in the slip.
- ④ BOW STOP**
Prevents your boat from overrunning the lift.

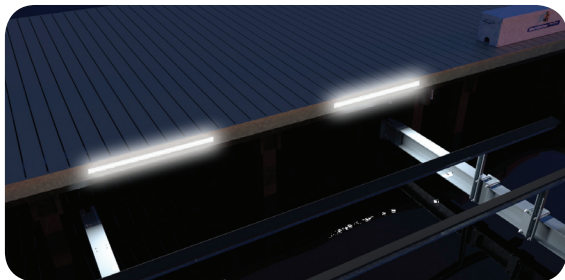

Lighting

LED STRIP LIGHT KIT

Two 39 inch, super bright, 24 V light strips mounted on the lift's tube or pilings for safety at night. Effortlessly controlled using your lift's wireless remote.

Boat Supports

Numerous boat support options to protect and support any watercraft.



SINGLE BUNK

Pivoting maintenance free aluminum/poly bunks are mounted on sturdy support channels to shoulder the load.

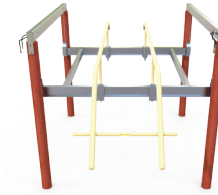

TOONRAIL

The 3-in-1 under-deck lift support with integrated motor stop and load guides is economical and maintenance free. The contoured poly-covered tubes both guide the pontoon into the lift and support it by simply lifting under the deck inside the outer tubes. Available on 4,000 - 8,000 lb lifts.



LOGRACK

The double UltraBunks and full length GlideRail load guides cradle and channel the outer "log" perfectly every time. The unique kit is designed to work well on both tritoons and standard pontoons with tubes up to 29". Available on 4,000 - 8,000 lb lifts.



TANDEM BUNK ON 15 & 20

Available with 2 supports that adjust to fit for larger watercraft. The premium poly-aluminum UltraBunks are often combined with under-deck post load guides to reduce lift width requirements. Available on 15,000 and 20,000 lifts.



DOUBLE PWC

Designed to fits today's big 3-person watercrafts. The platform & bunks adjust to fit 2 PWC's side by side.

Compare the features and discover why ShoreStation is far superior value!

Our revolutionary hydraulic design utilizes DC power to provide the fastest lift speeds on the market. Cables cannot be overwound or unspooled maximizing cable life, safety, and your time spent on the water.

The result...the fastest, safest, most reliable boat lift on the market!

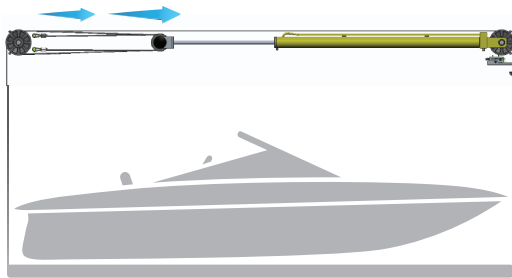

Cables pulled not wound

VS.

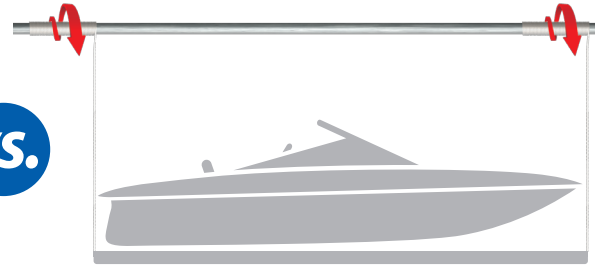

Cables wound around pole or winch drum

ShoreStation Hydraulic	Comparison Chart	Traditional Cable Winder
Up to 96" per minute*	Speed	Up to 40" per minute
Cannot overwind or unspool	Cable Protection	Easily unspool if cable goes slack
Safe Reliable DC with Solar Panel	Power Source	AC Circuit Required
15/6/3 Year Manufacturer's Warranty	Warranty	1 year
Hassle-free cable design, corrosion resistant materials, stainless cables and hardware	Maintenance	Annual inspections, cable greasing, re-string cables
Tandem pump auto levels	Level Lifting	Manual intervention to keep level
2 Key FOB remotes standard	Wireless Operation	Unavailable or upcharge
Corrosion free poly/aluminum UltraBunks conform to hull	Bunk Support	Rigid carpeted wood bunks

Performance Driven Freestanding Lifts

ShoreStation Boat Lifts

Whether you're looking for one of the safest, most dependable lifts on the market like the ShoreStation Hydraulic, or the simplicity of our original manual drive lift, ShoreStation continues to elevate the industry standards.

Made from the highest quality materials, our innovative hydraulic boat lift is one of the fastest and safest lifts on the market today. When you have a hydraulic lift, there's no need to worry about wind and waves getting in your way. This lift will give you confidence to safely land and secure your boat in less than ideal conditions.

